



SHIMADZU ELECTRONIC BALANCES

General Catalog



1875 ● Establishment of SHIMADZU CORPORATION

1920 ● 1918 Commence Tortion Balance and Top-pan Balance production



1930 **Model.5** Chemical Balance



1930 **1939** Large-capacity Balance

1940



1950 **DODIQ** Direct-Reading Balance

1950



1958 **Type L** Direct-Reading Balance

1960



1960 **AL-3** Automatic Direct-Reading Balance



1965 **AL-7** Automatic Direct-Reading Balance



1967 **LU-T1100** Top-loading Direct-Reading Balance

1970



1970 **AL-8** Automatic Direct-Reading Balance (All-digital display)



1970 **Digibalance D-1003** Electronic Balance



1973 **C-160** Direct-Reading Carat Balance



1976 **NL-200P** Direct-Reading Balance



1981 **EB-2800M** Electronic Animal Balance



1981 **AEL-160** Electronic Analytical Balance

● 1985 **AEL-200** Electronic Analytical Balance (Full-range electro-magnetic)

● 1985 **PSC** Fully-automatic calibration based on temperature change detection

● 1989 **EB-K** Precision platform balances with **OPF** (later renamed UniBloc)

1990



1993 **AEM-5200** Micro Balance

● 1997 First electronic balances with **WindowsDirect**

2000



2003 New UniBloc balance line-up



2004 **MOC-120H** UniBloc moisture balance



2007 **TX/TXB** UniBloc Top-loading balance



2010 **ATX/ATY** UniBloc Analytical balance



2011 **MOC63u** UniBloc moisture balance



SHIMADZU
ELECTRONIC BALANCES

Professional in
Measurement



SHIMADZU ELECTRONIC BALANCES

SHIMADZU : A Tradition of Weighing Expertise

Shimadzu Corporation was established in 1875 in Kyoto, Japan, as one of the pioneers of scientific precision instruments.

Top-pan and torsion balance production started in 1918, and equal-beam analytical balances were introduced in 1925. Since their release, the continuous improvement of Shimadzu balances has contributed to research and development across all industries.

Around the turn of the 20th Century, precision weighing was a time-consuming practice performed only by experienced operators. Placing the sample and small masses on pans hung from a beam scale with a moving indicator was a tedious process. Shimadzu strove continuously to streamline weighing procedures. The introduction of the direct reading analytical balance (patented in Japan in 1948) signified a new era in weighing technology. In the Type L balance, the sensitive mass-loading work was replaced by convenient dial operations. Users reduced weighing time by 66%, and consequently reduced demand for conventional balances.

Shimadzu then added the top-loading direct reading balance with Roberval's mechanism in 1959. Until recently many of these instruments were still utilized in modern laboratories.

Shimadzu continued to pioneer new technologies, releasing its first electronic balance in 1971-the Digibalance.

This release marked a milestone in precision weighing, introducing simplicity and ease of use to analytical weighing. Six years later (1977), the application of microprocessors in electronic balances further enhanced weighing performance. The compact ED Series provided substantial improvements in sensitivity, resolution, and stability.

More recently, Shimadzu has introduced user-friendly instruments and features to the market, such as : the temperature-based fully-automatic calibration in 1985, the first one-piece forcecell (OPF, later renamed UniBloc) in 1989, the high-sensitivity AEM-5200 Micro Balance in 1993, and the unique WindowsDirect feature perfectly suited for the computerized laboratory of the 21st Century.

Moving forward, Shimadzu is committed to providing innovative products for the analytical marketplace.

One of the latest achievements is AUW-D series, the world's first semi-micro balances with the advantages of UniBloc one-piece forcecell technology.

SHIMADZU
ELECTRONIC
BALANCES

APPLICATION
BALANCES

OTHERS

Contents

P 06 - Excellent performance for multiple industries	P 18 - UniBloc Precision Platform Balances	P 24 - Specific Gravity Measurement Kits
P 08 - Quick reference by capacity and minimum display	P 19 - Analytical Balances	P 24 - Animal Balances
P 08 - Features and Symbols	P 19 - Top-Loading Balances	P 25 - Optional Accessories
P 10 - UniBloc Analytical Balances	P 20 - Portable Electronic Balances	P 29 - Physical Dimensions
P 14 - UniBloc Top-Loading Balances	P 21 - UniBloc Electronic Moisture Balance	

Excellent performance for multiple



Pharmaceutical industry

- Sample preparation in R&D laboratories
- Quality assurance of drugs
- Material inspection



AUW220D
Capacity: 220g/82g
minimum display: 0.1mg/0.01mg
▶ P.10



UW1020H
Capacity: 1020g
minimum display: 0.001g
▶ P.14



MOC63u
Capacity: 60g
minimum display: 0.001g/0.01%
▶ P.22



Food industry

- Quality assurance of processed food
- Inspection for harvest before export
- Packaging final products



MOC63u
Capacity: 60g
minimum display: 0.001g/0.01%
▶ P.22



AUW220
Capacity: 220g
minimum display: 0.1mg
▶ P.12



TX3202L
Capacity: 3200g
minimum display: 0.01g
▶ P.16



Chemical industry

- Reagent preparations
- Manufacturing process inspection



AUW220
Capacity: 220g
minimum display: 0.1mg
▶ P.12



UX420H
Capacity: 420g
minimum display: 0.001g
▶ P.14

UX4200H
Capacity: 4200g
minimum display: 0.01g



MOC63u
Capacity: 60g
minimum display: 0.001g/0.01%
▶ P.22

industries

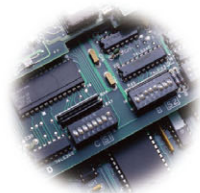

Electronic and semiconductor

- Piece counting for small parts in factories
- Measurement of thin film on the surface of silicon wafer
- Pass/fail by checkweighing



ATX224

Capacity: 220g
minimum display: 0.1mg

► P.13



UX420H

Capacity: 420g
minimum display: 0.001g

► P.14



UX4200H

Capacity: 4200g
minimum display: 0.01g

► P.14



TX323L

Capacity: 320g
minimum display: 0.001g

► P.16

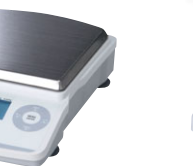

TX3202L

Capacity: 3200g
minimum display: 0.01g

► P.16



BL320H

Capacity: 320g
minimum display: 0.001g

► P.19



ELB300

Capacity: 300g
minimum display: 0.01g

► P.20



Jewelry market

- Jewelry making
- In retail shop
- Purity check



TXC623L / TWC623L

Capacity: 620ct
minimum display: 0.001ct

► P.17



TX323L

Capacity: 320g
minimum display: 0.001g

► P.17



TX3202L

Capacity: 3200g
minimum display: 0.01g

► P.17



UX420H

Capacity: 420g
minimum display: 0.001g

► P.14



UX4200H

Capacity: 4200g
minimum display: 0.01g

► P.14



TXB622L

Capacity: 620g
minimum display: 0.01g

► P.17

Quick reference by capacity and

Minimum display Capacity	0.01mg	0.1mg	0.001g	0.01g
30g	AUW120D	Semi-micro Balances (P.11)		
50g	AUW220D	ATX84 ATY64		
100g		AUW120D AUW/AUX/AUY120 AW/AX/AY120 ATX/ATY124		ELB120
200g		AUW220D AUW/AUX/AUY220 ATX/ATY224 AW/AY220 AX200	UW/UX220H BL220H TX/TW223L	ELB200 TXB222L
300g	Analytical Balances (P.12, P.13 and P.19)		BL320H TX/TW323L	ELB300 BL320S
400g		AUW/AUX320 AW320	UW/UX420H TX/TW423L	UW/UX420S TXB422L
600g			UW/UX620H UW/UX820H UW/UX1020H	BL620S TXB622L UW/UX820S
1200g				
2000g				UW/UX2200H BL2200H TX2202L
3000g				BL3200HL BL3200H TX3202L
4000g		Top-loading Balances		UW/UX4200H TX4202L
6000g		UW/UX Series (P.14)		UW/UX6200H
10000g		TW/TX/TXB/TWC/TXC (P.16 and P.17)		BL Series (P.19)

※Dual-range models appearing twice for both ranges.
(Capacity) UniBloc Family of Balances

Features and Symbols

REDUCE MANUAL CALIBRATION WORK

Perfect Self Calibration

The balance self-calibrates when it detects temperature changes that would affect accuracy. Operator is released from constantly monitoring surrounding conditions.

Clock-CAL

Fully automated feature initiates self-calibration at set time intervals, using motor-driven internal calibration weight. Up to three automatic calibrations per day may be pre-set to coincide with work schedules or to meet specific quality goals.

Internal Calibration

Calibration can be performed any time with a simple push-button operation.

One-lever CAL

Single lever operation loads and unloads built-in calibration weight.

GLP, GMP, AND ISO9000 CONFORMANCE

Calibration Report

With optional printer connected to the balance, calibration reports which meet the requirements of GLP, GMP, and ISO9000 can be produced.

Built-in Clock

Date and time can be readily supplied by the balance.

APPLICATION SPECIFIC FEATURES

WindowsDirect (See p.9)

Weighed result is directly typed at the cursor position of any application on Windows® OS. No communication software is required.

Built-in RS-232C Interface

RS-232C interface is a standard feature.

minimum display

0.1g

1g (Minimum display)

ELB600
TXB621L

ELB600S

TXB2201L

ELB1200

ELB2000

TXB4201L

ELB3000
BL3200S

UW/UX4200S 

TXB6201L

UW/UX8200S 

ELB6000S
TXB6200L

BW/BX12KH 
BW/BX22KH 
BW/BX32KH 

ELB12K 
BW/BX32KS 
BW/BX52KS 

**Precision
Platform Balances (P.18)**

**Portable Electronic
Balances (P.20)**

WindowsDirect
Experience it!

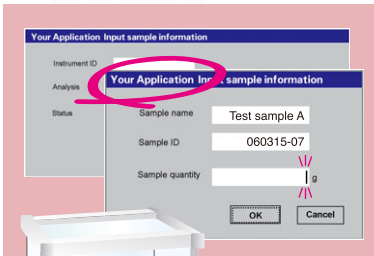

• Place the cursor at the desired position in your Windows application.



(1) Press [PRINT] key

• Press the [PRINT] key on the balance.



• The weighed result will be directly typed there.

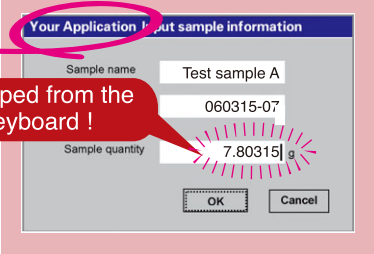

(2) Sent as if typed from the computer keyboard!

Any application on Windows® :
e.g. Excel, Word etc.

All that you need to add is **just one cable!**
No communication software is required!

• The weighed result will be directly typed there.

Any application on Windows® :
e.g. Excel, Word etc.

All that you need to add is **just one cable!**
No communication software is required!

If you'd like to use "WindowsDirect" with "Windows 7" "Windows VISTA", or USB port, please contact to our distributors.



Piece Counting Mode

Piece counting function is a standard feature.



Analog Bar Graph Display

Allows viewing of remaining capacity.



Specific Gravity Measurement

Software for specific gravity measurement is pre-installed. Simply add optional specific gravity kit for efficient measurements.



Standard Below-weigh Hook

Measurement beneath the balance is possible.



Interval Timer Output

Data can be automatically output at pre-set time intervals.



Auto Print

Data can be automatically output as each measurement is made.



Checkweighing

Utilized in quality control applications.



Dry Battery Operation

Portable for use in the field.

OTHER FEATURES



UniBloc

Single-block technology brings high performance and durability.



Backlight

Easy to read in any environment.



All-metal Housing

All metal construction for high durability.



Easy Setting

Best fit to weighing application



Menu Operation Key

Easy to operate key layout



UniBloc Family of Balances

[UniBloc Analytical Balances]

AUW-D series dual-range semi-micro balances
AUW/AUX/AUY series
ATX/ATY series

[UniBloc Top-loading Balances]

UW/UX/TW/TWC/TX/TXC series

[UniBloc Precision Platform Balances]

BW-K/BX-K series

[UniBloc Electronic Moisture Balances]

MOC-120H/MOC63u

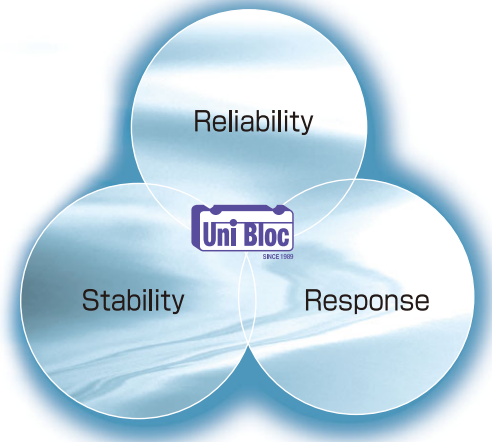

UniBloc Analytical Balances

AUW-D series dual-range semi-micro balances
 AUW/AUX/AUY series analytical balances

Excellent Weighing Performance

- Compact UniBloc mechanism and digital processing technology produce fast response and stability at the same time.
- Microprocessor digital control can be set to automatically provide the most suitable data processing for the installation environment and weighing application.

User-friendly Features

- Weighing work is made easy by the smooth door movement. It is easy to remove and replace the door rails for cleaning.
- The embossed key panel sheet provides clear clicking response as operated. The key operations can be confirmed with a gentle beeping sound, too.
- Level adjustment can be performed with ease.

For Application

- Shimadzu's unique WindowsDirect is a standard feature for all the UniBloc Analytical Balances. Measurement results can be transmitted to Excel or other Windows applications without any software installation to your computer. All you have to add is one RS-232C cable.
WindowsDirect works with Windows® 95, 98, NT4.0, 2000, ME and XP. PC must be IBM PC/AT compatible.
- Piece counting, various mass units, below-weigh hook, specific gravity measurement software are all standard features.





UniBloc Family of Balances

Shimadzu introduced one piece force cell technology for precision balances in 1989. Today's UniBloc is created by high-precision electric discharge wire processing applied to a block of aluminum alloy, and replaces the conventional electro-magnetic balance sensor assembly. UniBloc's compact, uniform structure ensures stable temperature characteristics, excellent response time and stable corner-load performance. The UniBloc design permits a consistency of production that assures reliability and a long operational life. The updated UniBloc technology expanded the UniBloc balance line up, which now ranges from semi-micro with minimum display of 0.01mg to precision platform balances up to 52kg in capacity.

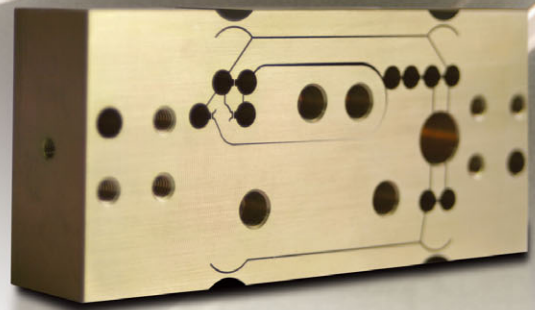

One piece force cell patented in USA in 1989, No.4799561, in China in 1991, No.12729, in Japan in 1995, No.1905686

Dual-range semi-micro balances



A UW-D dual-range semi-micro balances are the first five-decimal balances with the advantages of UniBloc one-piece force cell technology.

Choose one of the two models according to your field requirements.

Excellent response, stability and zero return performance – in a semi-micro balance.



Choice of fully-automatic calibrations : PSC and Clock-CAL

Operator can choose from two types of fully-automatic span calibration methods. "PSC" is initiated based on temperature change detection, and "Clock-CAL" operates at user pre-set times (up to three times a day).

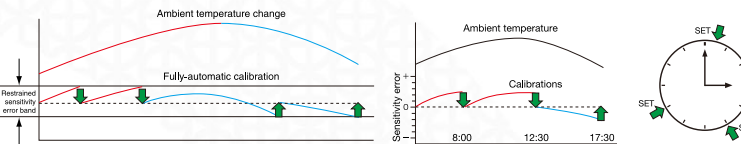

GLP/GMP/ISO calibration report

Calibration report can be automatically printed out with the optional electronic printer. Date and time are also output to meet GLP/GMP/ISO requirements.

WindowsDirect (See p.9)

Weighed data can be directly typed into any Windows application and no interface software is required. If you'd like to use "WindowsDirect" with "Windows 7" "Windows VISTA", or USB port, please contact to our distributors.

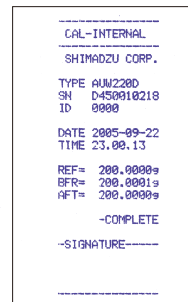

Model	Capacity	Minimum display	Pan size(mm)	Internal calibration	Internal calibration modes	WindowsDirect
AUW220D	220g/82g	0.1mg/0.01mg	80 dia	●	PSC, Clock-CAL, any time with key touch	●
AUW120D	120g/42g	0.1mg/0.01mg	80 dia	●	PSC, Clock-CAL, any time with key touch	●



UniBloc Analytical Balances

Analytical Balances

AUW/AUX/AUY Series



AUW/AUX/AUY models are the single-range analytical balances engineered with the UniBloc technology. This provides especially fast response and superb stability.

PSC, fully-automatic calibration (AUW/AUX models)

Calibration is carried out when temperature change has been detected.

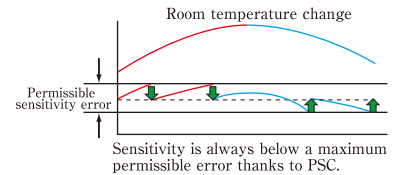

Clock-CAL, fully-automatic calibration (AUW model only)

Calibration carried out at user-preset times (up to three times a day). Operators can work without unexpected interruptions.

GLP/GMP/ISO calibration report (AUW/AUX models)

Meets requirements of GLP/GMP/ISO9000. Calibration reports can be output with date and time, provided by the built-in clock.



WindowsDirect (See p.9)

Weighed data can be directly typed into any Windows application and no interface software is required. If you'd like to use "WindowsDirect" with "Windows 7" "Windows VISTA", or USB port, please contact to our distributors.

Backlight LCD (AUW model only)

LCD with backlight can be read with ease and comfort under any lighting condition.



Data transfer port of AUW/AUX/AUY Series

Static Remover STABLO-EX(p.25)



Model	Capacity	Minimum display	Pan size(mm)	Internal calibration	Internal calibration modes	WindowsDirect
AUW320	320g	0.1mg	80 dia	●	PSC, Clock-CAL, any time with key touch	●
AUW220	220g	0.1mg	80 dia	●	PSC, Clock-CAL, any time with key touch	●
AUW120	120g	0.1mg	80 dia	●	PSC, Clock-CAL, any time with key touch	●
AUX320	320g	0.1mg	80 dia	●	PSC, any time with key touch	●
AUX220	220g	0.1mg	80 dia	●	PSC, any time with key touch	●
AUX120	120g	0.1mg	80 dia	●	PSC, any time with key touch	●
AUY220	220g	0.1mg	80 dia			●
AUY120	120g	0.1mg	80 dia			●



UniBloc Family of Balances

Analytical Balances

ATX/ATY Series



New

ATX



New

ATY



High specification and low cost with UniBloc.

Touch-key calibration

Automated calibration can be started by pressing keys. (ATX series)
Also, your external calibration weights can be used for span calibration. (All models)

Easy Setting Best fit to weighing application

Quickly adjust the desired ratio of stability and response for every application, even during measurement, with one-touch operation.

Expanded Piece Counting function

Unit weights of up to 5 different samples can be easily entered, stored and recalled for use.

Comparator function

Compare samples to target values or pass/fail criteria and clearly indicate the results.

Formulation mode

Convenient for making many measurements of minute samples and seeking the total mass.

WindowsDirect Communication Function

Send balance data to Excel or other Windows applications without any data communication software installation required. By combining standard AutoPrint functions with typical spreadsheet functions, even difficult applications can be easily automated
*IO-RS cable is needed.

Very large size pan

It enables the use of a large flask. (91 dia)



Data transfer port of ATX/ATY Series

Model	Capacity	Minimum display	Pan Size (mm) approx.	Main Body Dimensions (mm) approx.	Weight (kg) approx.	Power Requirement	Internal Calibration
ATX84	82g	0.1mg	91 dia	213(W)×356(D)×338(H)	6.2	12V, 1A	●
ATX124	120g	0.1mg	91 dia	213(W)×356(D)×338(H)	6.2	12V, 1A	●
ATX224	220g	0.1mg	91 dia	213(W)×356(D)×338(H)	6.2	12V, 1A	●
ATY64	62g	0.1mg	91 dia	213(W)×356(D)×338(H)	6.0	12V, 1A	
ATY124	120g	0.1mg	91 dia	213(W)×356(D)×338(H)	6.0	12V, 1A	
ATY224	220g	0.1mg	91 dia	213(W)×356(D)×338(H)	6.0	12V, 1A	



UniBloc Top-Loading Balances

Top-Loading Balances

UW/UX Series

- UW**              
- UX**           

New Line up!

UW820H/UW1020H
UX820H/UX1020H



The new line of Shimadzu top-loading balances are engineered with the UniBloc mechanism resulting in unrivaled response, stability and durability. Powerful features support any imaginable weighing application. UW Series includes internal calibration and fully-automatic calibration functions.



Large-pan model



Small-pan model
(minimum display 0.01g)



Small-pan model
(minimum display 0.001g)

* The delivered windbreak may differ from the photo

GLP/GMP/ISO calibration report

Meets requirements of GLP/GMP/ISO9000. Calibration reports can be output with date and time, provided by the built-in clock.

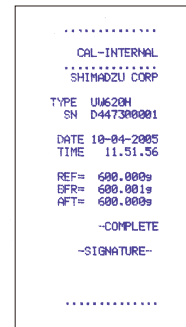

Example of calibration record

Analog display modes

Bar graph display

Bar graph clearly indicates the total weight (including the tare) as a portion of the balance capacity.

Target weighing

Select a target weight and tolerance. The display clearly indicates when they are reached.

Checkweighing

Set an upper and lower threshold. The display continually indicates whether the sample is within the range "GO", over range "HI" or under range "LO". Choose one of two checkweighing bar graph display modes.

The results can also be output to external devices.

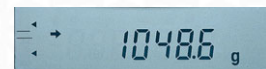

PSC, fully-automatic calibration (UW only)

Calibration is carried out when temperature change has been detected.

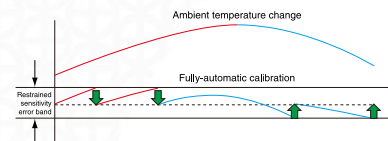

Clock-CAL, fully-automatic calibration (UW only)

Calibration carried out at user-preset times (up to three times a day).

Operators can work without unexpected interruptions.

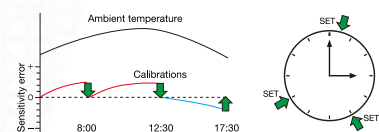

WindowsDirect (See p.9)

Weighed data can be directly typed into any Windows application and no interface software is required. If you'd like to use "WindowsDirect" with "Windows 7" "Windows VISTA", or USB port, please contact to our distributors.



Auto Print

Automatically outputs data as each measurement is made. Combination with WindowsDirect makes up a handy weigh-and-record system.

Auto Print and WindowsDirect

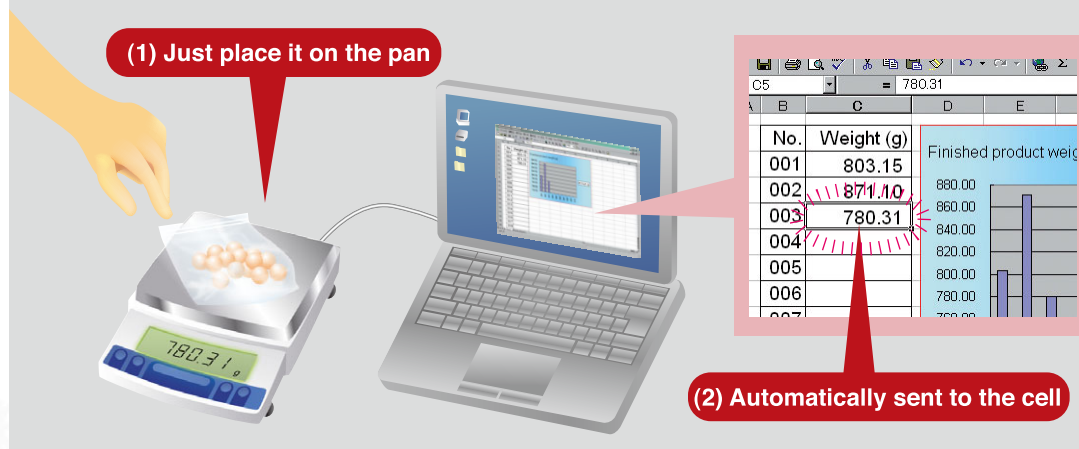

All that you need to add is **just one cable!**

No communication software is required! Available as standard with AUW-D/AUW/AUX/AUY, ATX/ATY, UW/UX, TW/TX/TWC/TXC/TXB, BW-K/BX-K series, MOC-120H, MOC63u

If you'd like to use "WindowsDirect" with "Windows 7" "Windows VISTA", or USB port, please contact to our distributors.

Back light LCD

LCD with back light can be read with ease and comfort under any lighting condition.

Unit conversion and piece counting function

Weight value can be presented in 22 different units and modes, including percentage, carat, specific gravity, lb, oz, and others. Users can pre-register any combination of units depending on their needs. Piece counting function is standard.



Data transfer port of UW/UX Series

Model	Pan type	Capacity	Minimum display	Pan size(mm) approx.
UW220H*	Small-pan	220g	0.001g	108X105
UW420H*	Small-pan	420g	0.001g	108X105
UW620H*	Small-pan	620g	0.001g	108X105
New UW820H	Small-pan	820g	0.001g	108X105
New UW1020H	Small-pan	1020g	0.001g	108X105
UW2200H	Large-pan	2200g	0.01g	170X180
UW4200H	Large-pan	4200g	0.01g	170X180
UW6200H	Large-pan	6200g	0.01g	170X180
UW420S	Small-pan	420g	0.01g	108X105
UW820S	Small-pan	820g	0.01g	108X105
UW4200S	Large-pan	4200g	0.1g	170X180
UW8200S	Large-pan	8200g	0.1g	170X180

*Models with minimum display of 0.001g come with a standard windbreak.

Model	Pan type	Capacity	Minimum display	Pan size(mm) approx.
UX220H*	Small-pan	220g	0.001g	108X105
UX320G	Small-pan	320g	0.001g	108X105
UX420H*	Small-pan	420g	0.001g	108X105
UX620H*	Small-pan	620g	0.001g	108X105
New UX820H	Small-pan	820g	0.001g	108X105
New UX1020H	Small-pan	1020g	0.001g	108X105
UX2200H	Large-pan	2200g	0.01g	170X180
UX3200G	Large-pan	3200g	0.01g	170X180
UX4200H	Large-pan	4200g	0.01g	170X180
UX6200H	Large-pan	6200g	0.01g	170X180
UX420S	Small-pan	420g	0.01g	108X105
UX820S	Small-pan	820g	0.01g	108X105
UX4200S	Large-pan	4200g	0.1g	170X180
UX8200S	Large-pan	8200g	0.1g	170X180



UniBloc Top-Loading Balances

Top-Loading Balances

TW/TX/TXB Series



TW/TX series only

TW									
TX									
TXB									



The beginning of the new standard.
Extremely capable, but easy to operate.

Internal Calibration (TW series only)

Calibration can be performed any time with a simple push-button operation.

Easy Setting

Easy Setting Best fit to weighing application

Quickly adjust the desired ratio of stability and response for every application, even during measurement, with one touch operation provided by the built-in clock.

Menu Operation Key

Menu Operation Key Easy to operate key layout

Menu navigation keys are separated from weighing operation keys and arranged in a familiar 5-way navigation circle. Up, Down, Right, Left and Enter are the simple steps of menu operation.

WindowsDirect (See p.9)

Weighed data can be directly typed into any Windows application and no interface software is required.

If you'd like to use "WindowsDirect" with "Windows 7" "Windows VISTA", or USB port, please contact to our distributors.

Can be used anywhere with battery power (TXB only)

Battery power the TXB series balances by AC adapter or batteries.

Power saving function

If you don't operate for a given length time, power (TXB) or display (TX) can be turned off automatically.

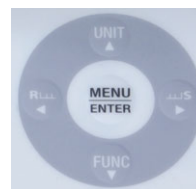

Model	Pan type	Capacity	Minimum display	Pan size (mm) approx.
TX223L	Small-pan	220g	0.001g	φ 110
TX323L	Small-pan	320g	0.001g	φ 110
TX423L	Small-pan	420g	0.001g	φ 110
TX2202L	Large-pan	2200g	0.01g	167(W) × 181(D)
TX3202L	Large-pan	3200g	0.01g	167(W) × 181(D)
TX4202L	Large-pan	4200g	0.01g	167(W) × 181(D)
TW223L	Small-pan	220g	0.001g	φ 110
TW323L	Small-pan	320g	0.001g	φ 110
TW423L	Small-pan	420g	0.001g	φ 110

Model	Pan type	Capacity	Minimum display	Pan size (mm) approx.
TXB222L	Small-pan	220g	0.01g	φ 110
TXB422L	Small-pan	420g	0.01g	φ 110
TXB622L	Small-pan	620g	0.01g	φ 110
TXB2201L	Large-pan	2200g	0.1g	φ 160
TXB4201L	Large-pan	4200g	0.1g	φ 160
TXB6201L	Large-pan	6200g	0.1g	φ 160
TXB621L	Small-pan	620g	0.1g	φ 110
TXB6200L	Large-pan	6200g	1g	φ 160



UniBloc Family of Balances

Jewelry & Gold Balances

TWC/TXC/TW/TX/TXB Series

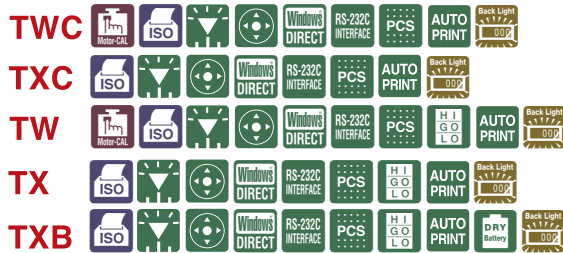

Weighing gold in a local unit

Various weighing units including Tael (Hong Kong, Taiwan, Singapore, Malaysia, China) plus user-defined unit are available.

Counting coins or parts

Piece counting function is standard.

Pass/fail checkweighing

According to the user-preset thresholds, GO (pass), HI (over) or LO (under) will be displayed.

Production/sales management using computer

WindowsDirect function directly types the weighed results to any Windows application you are using (e.g. Excel) without interface software required. (TX series)
If you'd like to use "WindowsDirect" with "Windows 7" "Windows VISTA", or USB port, please contact to our distributors.

Internal Calibration (TW/TWC series only)

Calibration can be performed any time with a simple push-button operation.

Battery operation (TXB)

TXB may be operated with dry batteries. Suitable for sites where reliable power supply is not available.

*1 If you need PSC or timer calibration, please select UW series.

*2 If a second display is required, please select UX/UW series.



Data transfer port of TWC/TXC/TW/TX Series



Data transfer port of TXB Series

Model	Capacity	Minimum display	Pan size (mm) approx.
TXC323L	320ct	0.001ct	80 dia
TXC623L	620ct		
TWC323L	320ct		
TWC623L	620ct		
TX223L	220g	0.001g	110dia
TX323L	320g	0.001g	110dia
TX423L	420g	0.001g	110dia
TX2202L	2200g	0.01g	167(W) x 181(D)
TX3202L	3200g	0.01g	167(W) x 181(D)
TX4202L	4200g	0.01g	167(W) x 181(D)
TW223L	220g	0.001g	110dia
TW323L	320g	0.001g	110dia
TW423L	420g	0.001g	110dia

Model	Capacity	Minimum display	Pan size (mm) approx.
TXB222L	220g	0.01g	110dia
TXB422L	420g	0.01g	110dia
TXB622L	620g	0.01g	110dia
TXB2201L	2200g	0.1g	160dia
TXB4201L	4200g	0.1g	160dia
TXB6201L	6200g	0.1g	160dia
TXB621L	620g	0.1g	110dia
TXB6200L	6200g	1g	160dia



UniBloc Precision Platform Balances

Precision Platform Balances

BW-K/BX-K Series

- BW-K**         
- BX-K**         

The Shimadzu Precision Platform balances have been engineered with the innovative UniBloc mechanism since 1989. Powerful features support any imaginable weighing application. BW-K Series includes internal calibration weight.



BW-K Series

GLP/GMP/ISO calibration report

Meets requirements of GLP/GMP/ISO9000. Calibration reports can be output with date and time, provided by the built-in clock.



Data transfer port of BW-K/BX-K Series

Analog display modes

Bar graph display

Bar graph clearly indicates the total weight (including the tare) as a portion of the balance capacity.

Target weighing

Select a target weight and tolerance. The display clearly indicates when they are reached.

Checkweighing

Set an upper and lower threshold. The display continually indicates whether the sample is within the range, "GO"; over range, "HI"; or under range, "LO". Choose one of two checkweighing bargraph display modes.

WindowsDirect (See p.9)

Weighed data can be directly typed into any Windows application and no interface software is required.

If you'd like to use "WindowsDirect" with "Windows 7" "Windows VISTA", or USB port, please contact to our distributors.

Large-size calibration weight (BW-K only)

For accurate internal calibration. Calibration can be performed by simple lever operation.

Model	Capacity	Minimum display	Pan size(mm) approx.	Calibration weight
BW12KH	12kg	0.1g	345X250	Built-in
BW22KH	22kg	0.1g	345X250	Built-in
BW32KH	32kg	0.1g	345X250	Built-in
BW32KS	32kg	1g	345X250	Built-in
BW52KS	52kg	1g	345X250	Built-in

Model	Capacity	Minimum display	Pan size(mm) approx.	Calibration weight
BX12KH	12kg	0.1g	345X250	External
BX22KH	22kg	0.1g	345X250	External
BX32KH	32kg	0.1g	345X250	External
BX32KS	32kg	1g	345X250	External
BX52KS	52kg	1g	345X250	External

Analytical Balances

Analytical Balances

AW/AX/AY Series



Fully-automatic calibration; PSC (AW only)

Calibration is carried out when temperature change has been detected.

Clock-CAL function (AW only)

Calibration carried out at user-preset times (up to three times a day). Operators can work without unexpected interruptions.

GLP/GMP/ISO calibration report

Meets requirements of GLP/GMP/ISO9000. Calibration reports can be output with date and time, provided by the built-in clock.

WindowsDirect (See p.9)

Weighed data can be directly typed into any Windows application and no interface software is required. If you'd like to use "WindowsDirect" with "Windows 7" "Windows VISTA", or USB port, please contact to our distributors.

Unit conversion

Automatic unit conversion at the push of a button. Carat, and other units are standard.

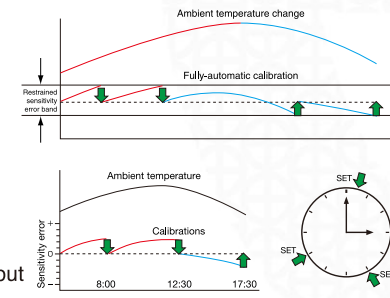

Data transfer port of AW/AX/AY Series

Model	Capacity	Minimum display	Pan size (mm)	Internal calibration	Internal calibration modes	Windows Direct
AW320	320g	0.1mg	80 dia	●	PSC, Clock-CAL, any time with key	●
AW220	220g	0.1mg	80 dia	●	PSC, Clock-CAL, any time with key	●
AW120	120g	0.1mg	80 dia	●	PSC, Clock-CAL, any time with key	●
AX200	200g	0.1mg	80 dia	●	any time with key touch	●
AX120	120g	0.1mg	80 dia	●	any time with key touch	●
AY220	220g	0.1mg	80 dia			●
AY120	120g	0.1mg	80 dia			●

Top-Loading Balances

Top-Loading Balances

BL Series



High-resolution balances made affordable



Large-pan model

Small-pan model

Small-pan model with windbreak

BL3200HL

Quick response

Very fast response for operator comfort and efficiency.

Piece counting function

Piece counting function is standard.

Analog bar graph display

Remaining weighing capacity can be seen at a glance.

Compact body

This electro-magnetic precision balance is as compact as a portable scale.



Data transfer port of BL Series

Model	Pan type	Capacity	Minimum display	Pan size(mm) approx.
BL220H *	Small-pan	220g	0.001g	100X100
BL320H *	Small-pan	320g	0.001g	100X100
BL2200H	Large-pan	2200g	0.01g	164X124
BL3200H	Large-pan	3200g	0.01g	164X124
BL3200HL	Large-pan	3200g	0.01g	164X124
BL320S	Small-pan	320g	0.01g	100X100
BL620S	Large-pan	620g	0.01g	164X124
BL3200S	Large-pan	3200g	0.1g	164X124

*Models with minimum display of 0.001g come with a standard windbreak.

Portable Electronic Balances

Portable Electronic Balances

ELB Series



Optional battery operation makes it readily portable with no compromise in accuracy.



High sensitivity and stability

Improved internal resolution provides extra accuracy.

Quick response

Stable results are quickly displayed.

Various application modes

Piece counting, percent display, and specific gravity modes are easily accessible.

Standard specific gravity software

Optional specific gravity kit is available for extra efficiency.

Digital stability control

User-selectable parameters for high-vibration environments provide dependable results.

Two-way power supply (AC or Battery operation)

Battery operation makes it portable

Model	Pan type	Capacity	Minimum display	Calibration weight
ELB120	Small-pan	120g	0.01g	110dia
ELB200	Small-pan	200g	0.01g	110dia
ELB300	Small-pan	300g	0.01g	110dia
ELB600	Large-pan	600g	0.05g	170X130
ELB600S	Large-pan	600g	0.1g	170X130
ELB1200	Large-pan	1,200g	0.1g	170X130
ELB2000	Large-pan	2,000g	0.1g	170X130
ELB3000	Large-pan	3,000g	0.1g	170X130
ELB6000S	Large-pan	6,000g	1g	170X130
ELB12K	Large-pan	12,000g	1g	170X130



Data transfer port of ELB Series

Totally portable



This whole system can be operated with dry batteries.



Application Balances

UniBloc Electronic Moisture Balance

MOC-120H



Large sample pan and capacity allow any sample to be placed for the best drying conditions.

Reliable UniBloc weighing mechanism and unique continuous auto-tare system assure accurate measurements.

Large sample pan and continuous auto-tare mechanism

A larger sample pan contributes to accurate measurements, but the larger heat capacity of it normally results in a larger zero drift in the precision weighing.

The MOC-120H is equipped with a unique continuous auto-tare mechanism, which eliminates the zero drift continuously and ensures high accuracy, even with a larger sample pan.

UniBloc technology for precision weighing

Shimadzu's UniBloc cell is used as the core mechanism of the weighing part.

Its uniform structure maintains the high performance of precision weighing under repeated heating / cooling.

Mid-wave infrared quartz heater

Mid-wave infrared quartz heater provides effective drying for a wide range of samples. Besides the excellent drying performance, it offers a long operational life of 20,000 to 30,000 hours.

Therefore, the long-term operational cost is much lower than halogen lamp heaters.

Predictive measuring mode

The final result can be predicted from the drying process, saving time in repeated measurements.

WindowsDirect

Complete sample data and instrument settings can be directly typed into any application on Windows® and no interface software is required.

If you'd like to use "WindowsDirect" with "Windows 7" "Windows VISTA", or USB port, please contact to our distributors.

Dimensions

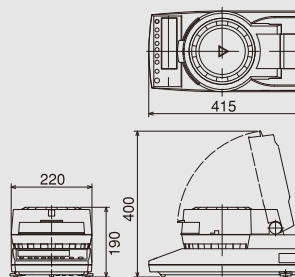

MOC-120H with 130mm sample pan



Data transfer port of MOC-120H

Measuring method	Heat drying and weight loss
Sample pan size	130 mm dia
Sample pan material	Stainless steel
Minimum display in weighing	0.001g
Measurement range of moisture content	0.01% to 100.00 %
Moisture content minimum display	0.01%
Sample capacity	120g
Measurement modes	Automatic or Timed ending modes, Standard, Rapid, Slow and Step drying modes, Predictive Measuring mode
Drying heater	Mid-wave infrared quartz heater
Temperature range	30 to 200°C (by 1°C increments)
Digital output	Complete test data including instrument settings can be output. Optional electronic printer prints the data in tabular or graphical style. Excel® Spread Sheets can receive the data without communication software (WindowsDirect).
Dimensions	220W X 415D X 190H (mm)
Weight	4.5kg
Operational temperature and humidity range	5 to 40°C, 85% RH or lower
Power requirements	AC100 to 127 / 220 to 240V, 640W maximum
Stored procedures	10
Standard accessories	Sample pan 2pcs, Sample pan handler 2pcs, Aluminum sheet 20pcs, Spoon, Spatula
Optional accessories	Temperature calibration kit, Electronic printer, RS-232C Cable
Consumables	Aluminum sheet 500pcs, Printer paper for optional electronic printer

Optional Accessories

Temperature calibration kit

The temperature at the sample position can be directly measured.



Electronic printer

Measurements can be printed out in tabular or graphical style.



Read instruction manual and understand before use of this instrument.

- Use this instrument for measurements in which water vaporizes from the sample under heating.
- The temperature of the heater installed in this instrument becomes higher than the set heating temperature for the sample.
- Any sample that is explosive, inflammable or may cause hazardous reaction under heating must not be measured with this instrument.



Application Balances

UniBloc Electronic Moisture Balance

New MOC63u



Easy operation -Automatic starting mode-

Easy-to-operate software and key layout. Automatic starting mode saves measurement time.



Backlight display

Illuminated display provides comfortable display visibility in all settings.



Compact design

MOC63u is one of the most compact instruments in its class. Width is only 202 (mm).

Data management -WindowsDirect-

The measurement conditions and data can be stored in MOC63u. Data IO for printer, RS-232C and USB connection for PC are available as standard. Send balance data to Excel or other Windows applications.



Data transfer port of MOC63u

Measurement data

With WindowsDirect



For food industry

Measurement data of soft flour

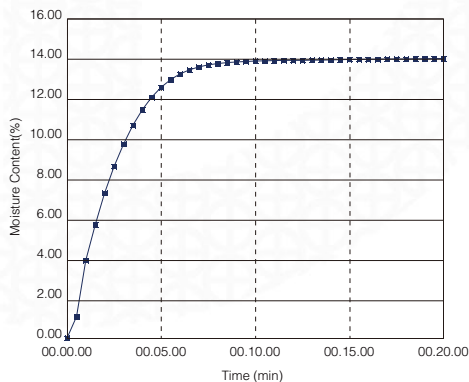

Soft flour



For chemical industry

Measurement data of resin pellet

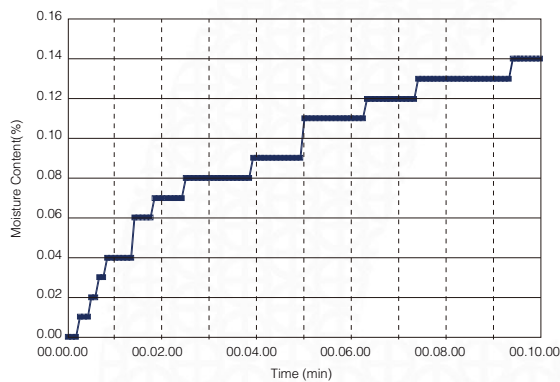

Resin pellet

Large pan size

Large sample pan: ϕ 95mm diameter



Long lifetime halogen heater

Halogen heater promises you quick and accurate measurement.



Maintenance

It's very easy to clean up and replace the halogen lamp.



Easy to remove



Measurement modes of MOC63u

Choose the right measuring mode for your application.

Ending modes

Automatic ending mode

Automatically ends measurement when moisture loss over the previous 30 seconds becomes smaller than specified percentage.

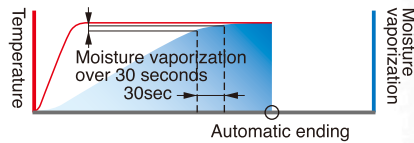

Timed ending mode

Automatically ends measurement when the specified amount of time has elapsed.

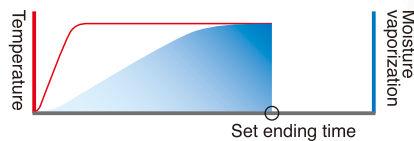

Alternate drying modes

Rapid drying mode

First dries with the highest temperature for the specified period, then shifts to the specified temperature shortening

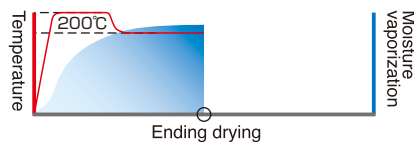

Slow drying mode

Gently heats samples that might solidify at the surface or samples that reduce under

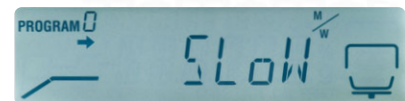
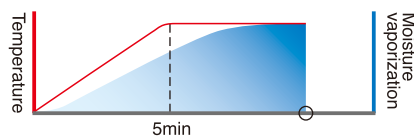

Step drying mode

Allows step-by-step changes in drying conditions. This feature is useful when measuring samples that contain a large amount of water.

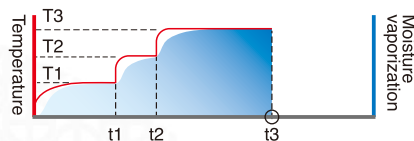

Starting mode

Automatic starting mode

Starts measurement immediately after closing the lid. It will save time in repeated measurement.



Capacity	Max	60 g
	Min	0.02g
Minimum readability		0.001g
		0.01/0.1% (Selectable)
Repeatability		0.15% (2g)
		0.05% (5g)
		0.02% (10g)
Drying Heater	Straight type halogen heater	
Power	400W	
Temperature range setting	50-200°C (1°C increments) (There is a time restriction when exceeding 180°C.)	
Display	LCD with backlight	
Pan size	φ 95mm	
Dimensions (WxDxH) mm	202 × 336 × 157	
Weight	4kg	
Operational temperature and humidity range	5 to 40°C, 85%RH or lower	

Measurement modes	Standard (Easy start/Automatic end/Timed end)
	Rapid drying (Easy start/Automatic end/Timed end)
	Slow drying (Easy start/Automatic end/Timed end)
	Step drying (Easy start/Automatic end/Timed end)
Timer setting	1-120 minutes or continuous (max 12 hours)
Interface	RS-232C (9-pin connector) I/O port USB port
Measurement conditions data memory	10
Data memory	100
Temperature calibration kit	Option

Application Balances, Optional Accessories

SMK Specific Gravity Measurement Kits

Simple specific gravity meters based on precision balances.

Combine your Shimadzu balance with a specific gravity measurement kit for handy specific gravity measurements. Software for specific gravity measurement is pre-installed in all AUW-D / AUW / AUX / AUY, AW / AX / AY, UW / UX, and ELB Series.

Order one of the balances and the corresponding specific gravity measurement kit.

Liquid density can also be measured with a sinker (except for ELB Series).



SMK-101



SMK-401

Model	Balance Series	Reduced Capacity (approx.)	Sample Phase	
			Solid	Liquid
SMK-401	AUW-D/AUW/AUX/AUY	0g	●	●
SMK-301	AW/AX/AY	0g	●	●
SMK-101	UW/UX (Capacity 2200g or more)	100g	●	●
SMK-102	UW/UX (Capacity 420g-820g)	270g	●	●
SMK-201	ELB (Capacity 600g-6000g)	200g	●	

A sinker is additionally needed for liquid density measurement.

Animal Balances



UW*

UX*

BW-K*

BX-K*

* When animal weighing mode is not used, all the functions indicated on p.14 and p.18 are available.

Electronic Balances for Weighing Animals

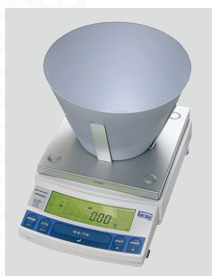

UW Series



BW-K plus Medium-size Animal Bucket



BW-K plus Large Animal Bucket

Dedicated software functions quick and reliable results in live animal weighing applications

Upon removing the weighed animal, the balance is automatically reset to zero regardless of deposited material.

Display response and stability can be optimized for the level of animal movement conditions.

Model	Balance Series	Reduced Capacity (approx.)
Small Animal Bucket set	UW/UX (Capacity 2200g or more)	Bottom 110dia, Top 200dia, Height 130
Medium-size Animal Bucket set *1	BW-K	Bottom 305 X 215, Top 377 X 245, Height 215
	BX-K	
Large Animal Bucket set *2	BW-K (Capacity 22kg or more)	Bottom 335 X 245, Top 445 X 395, Height 345
	BX-K (Capacity 22kg or more)	

*1 Capacity is reduced about 2kg

*2 Capacity is reduced about 6kg

Optional Accessories

Electronic Printer

EP-80

EP-90



EP-80



EP-90

Dimensions

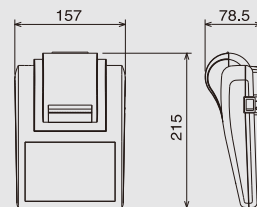

Common features for EP-80 and EP-90

- Simple connection to balances using the cable provided.
- Uses normal paper, suitable for long-term storage compatible with GLP/GMP/ISO (dot impact method).
- Operation can be powered by AC adapter or dry batteries
- Hassle-free long-use printer paper rolls (8000 lines of printing with one roll).
- High-speed printing at approx. 3 lines/sec (printer mechanism performance).
- Installed with statistical calculation function as standard.
- Can be used simultaneously with Shimadzu's unique WindowsDirect function (output to computer).

EP-90 Capable of Attaching Sample/ID Numbers, Date and Time to Each Measurement Result

- Equipped with keyboard, capable of defining ID number (fixed input number), and sample number (number input and then increased automatically with each printing).
- Printing of date and time (when connected to an electronic balance with a built-in clock) can be controlled from the printer.
- Multiplication and comparator functionality built-in.

DATE 2006-08-31	
TIME 14.45.37	
ID: 780315	
No. 0010203001	0.07402g
DATE 2006-08-31	
TIME 14.46.11	
ID: 780315	
No. 0010203002	0.04959g
DATE 2006-08-31	
TIME 14.46.39	
ID: 780315	
No. 0010203003	0.08834g

EP-90 print-out sample

Static Remover

STABLO-EX

Shimadzu's unique
2-WAY ionizer

Hand-held / On stand

Secure static removal

The excellent ion polarity balance achieved by the alternating method ensures :

- No inverse charging
- Wide angle static removal
- High performance maintained over a long period of use

Space saving design

Compact main unit requires minimal space. Holder height and angle are adjustable.



Quickly discharge container or bulk samples with fan ON.



For powdered samples, fan can be turned OFF.



As a handheld unit

Optional Accessories

Accessories for Shimadzu Balances

	AUW-D AUW AUX AUY	ATX ATY	AW AX AY	UW UX	TX	TXB	BL	ELB	BW-K BX-K	MOC-120H	MOC63u
EP-80 	✓	✓	✓	✓	✓	✓	✓	✓	✓		✓
EP-90 											
Printer for MOC-120H 										✓	
IFB-102A-UNC 	[no need]	✓	[no need]	[no need]	[no need]	[no need]	✓	✓	[no need]	[no need]	
IO-RS Cable 	[no need]	✓	[no need]	[no need]	[no need]	[no need]	✓	✓	[no need]	[no need]	[no need]
AKB-301 Application key board 	✓			✓					✓		
Windbreak WBC-102 for UW/UX small-pan type 				✓							
Large size windbreak WBC-502 for UW/UX Series 				✓							

Optional accessories list

Balances	Optional accessories
AUW-D/ AUW / AUX / AUY Series	Electronic Printer EP-80 / EP-90
	Foot Switch FSB-102TK (For taring)
	Foot Switch FSB-102PK (For printing)
	Specific Gravity Measurement Kit SMK-401
	Application Keyboard AKB-301
	RS-232C Cable, for IBM PC/AT Compatibles (25P-9P, Null modem, 1.5m)
	In-use Protective cover (5pcs)
ATX / ATY Series	EP80/90
	IFB-102A-UNC
	USB Conversion Kit
	In-use Protective cover(5pcs)
	IO-RS Cable
AW / AX / AY Series	Electronic Printer EP-80 / EP-90
	Foot Switch FSB-102TK (For taring)
	Foot Switch FSB-102PK (For printing)
	Specific Gravity Measurement Kit SMK-301
	RS-232C Cable, for IBM PC/AT Compatibles (25P-9P, Null modem, 1.5m)

Balances	Optional accessories
BL Series	Electronic Printer EP-80 / EP-90
	In-use Protective Cover (5 pcs)
	Simple Windbreak
	Lid for Simple Windbreak
	IFB-102A-UNC
ELB Series	Electronic Printer EP-80 / EP-90
	RS-232C Interface IFB-102A-UNC
	In-use Protective Cover (5 pcs)
	Specific Gravity Measurement Kit SMK-201 (Cannot be used with small-pan models)
Balances	Optional accessories
TX / TW / TXB / TXC / TWC Series	Electronic Printer EP-80 / EP-90
	In-use Protective Cover (5 pcs)
	RS-232C Cable

	AUW-D AUW AUX AUW	ATX ATY	AW AX AY	UW UX	TX	TXB	BL	ELB	BW-K BX-K	MOC-120H	MOC63u
USB conversion kit with RS-232C cable	✓	✓	✓	✓	✓	✓	✓	✓	✓	*1	✓
Foot switch for print FSB-102PK	✓			✓					✓		
for TARE FSB-102TK	✓			✓					✓		
for print FSB-101P			✓								
for TARE FSB-101T			✓								
Specific gravity measurement kit	SMK-101, -102 (Please see P. 24)			✓							
	SMK-201 for ELB large-pan model							✓			
	SMK-301 (Please see P. 24)		✓								
	SMK-401 AUW Series with SMK-401 (Please see P. 24)	✓									
Battery for Balance The down trance is needed.	✓	✓	✓	✓	✓	✓	✓		✓		
Interface for comparator IFB-RY1				✓							
Comparator lamps 100V *2 (needs IFB-RY1 and RY1 Connection Cable)				✓							
Comparator buzzer (needs IFB-RY1 and RY1 Connection Cable)				✓							

*1 USB serial adaptor and RS232C cable for MOC are needed.

*2 Not available in EU.

Balances	Optional accessories		
UW / UX Series	Electronic Printer EP-80 / EP-90 •	Comparator Lamps 100V (needs IFB-RY1 and RY1 Connection Cable)*2	
	RS-232C Interface IFB-102A (for multiple connection) •	Interface for comparator IFB-RY1 100V	
BW-K / BX-K Series (items with • only)	Small Size Windbreak (for models with capacity of 300g to 620g only) (Std Acc. for models with readability of 1mg)	Foot Switch FSB-102PK (For printing) • Foot Switch FSB-102TK (For taring)	
	Glass Windbreak (for models with capacity of 220g to 820g only)	RS-232C Cable, for IBM PC/AT Compatibles (25P-9P, Null modem, 1.5m)	
	Large Size Windbreak (for all models)	RS-232C Cable, for multiple connection (25P-25P, Null modem, 1.5m)	
	Specific Gravity Measurement Kit SMK-101 (for models with capacity of 2200g and up only)	Application Keyboard AKB-301 • Remote Display Unit RDB-201 with operation keys	
	Specific Gravity Measurement Kit SMK-102 (for models with capacity of 420g to 820g only)	Remote Display Unit RDB-202 Angle Adjuster and Wall Hook for Remote Display	
	In-use Protective Cover (5 pcs)	Stand for Remote Display (1m high)	
	MOC63u	Printer EP-80	Temperature calibration kit
		Printer EP-90	Sample pan (SUS)
In-use protection cover for display (5 pieces)		RS-232C cable	
Aluminum sheet		USB connection cable	
Fiberglass sheet		Halogen heater for replacement	

Optional accessories Dimensions

Optional accessories Dimensions

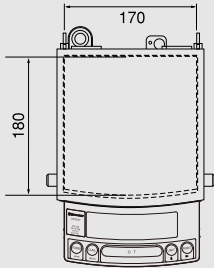

UW/UX large-pan model with large size windbreak (optional accessory)

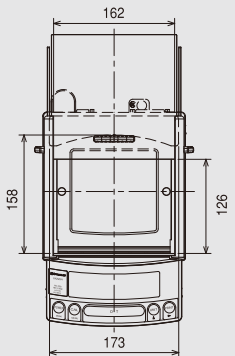
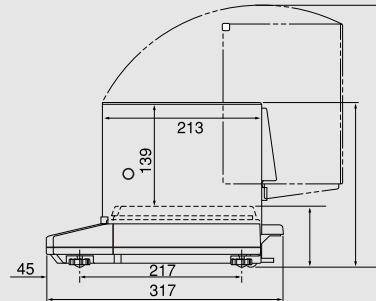
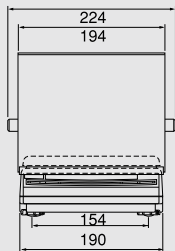

UW/UX small-pan model with glass windbreak (optional accessory)

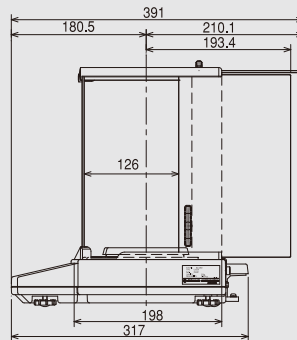
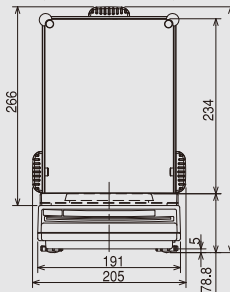

Physical Dimensions

Measurements in mm. 1mm=.03937"

AUW-D/AUW/AUX/AUY Series

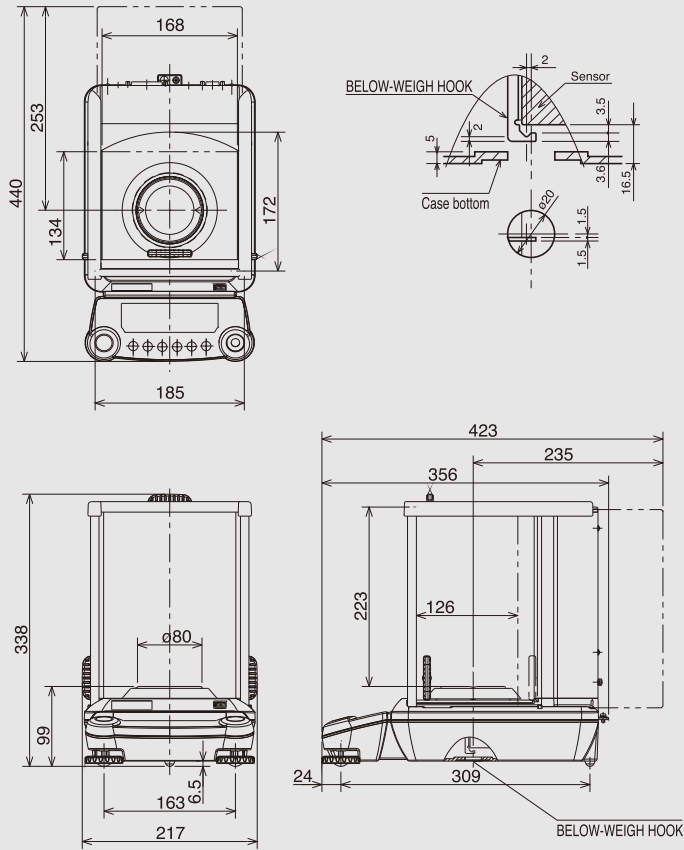

ATX/ATY Series

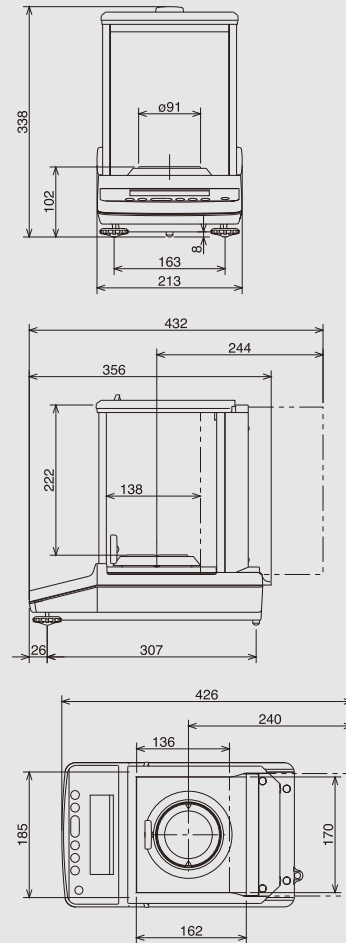

AW/AX/AY Series

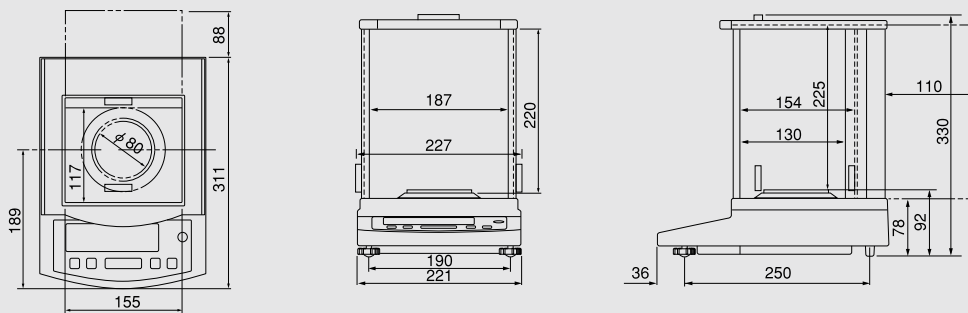

Physical Dimensions

UW/UX Series

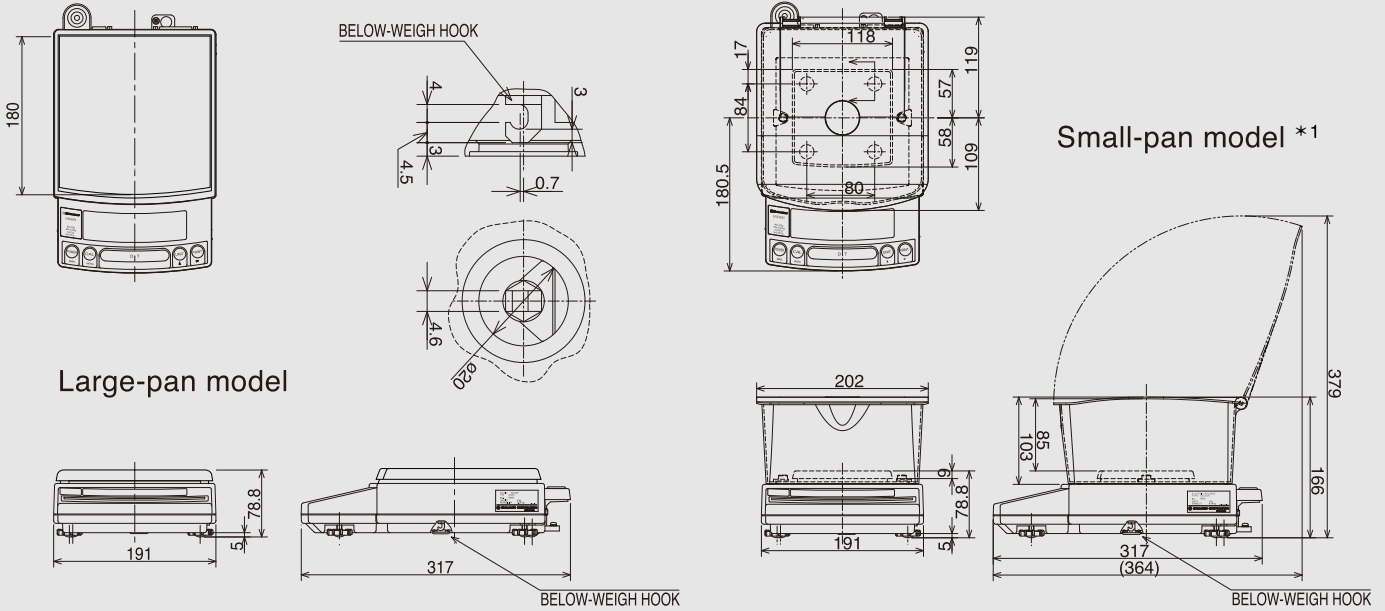

*1 Figure shows combination with simple windbreak (standard only for models with minimum display of 0.001g)
The delivered windbreak may differ slightly in size and shape.

BL Series

Large-pan model

Small-pan model

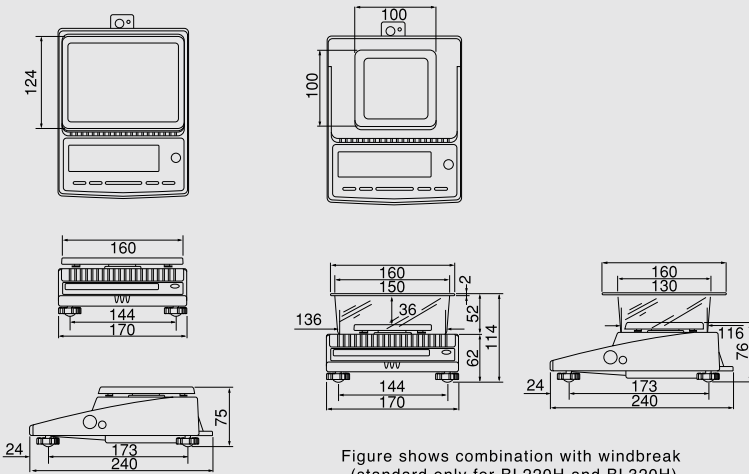

ELB Series

Large-pan model

Small-pan model

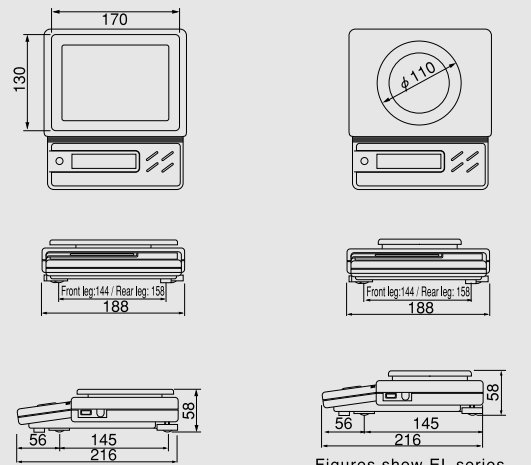

Measurements in mm. 1mm=.03937"

BW-K/BX-K Series

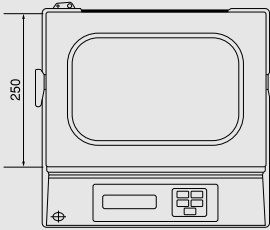

BW-K Series

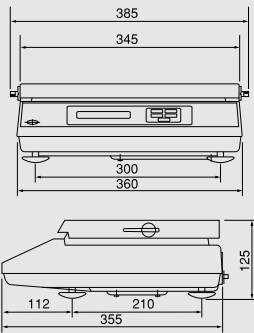

BX-K Series

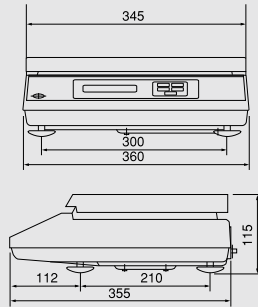

MOC63u

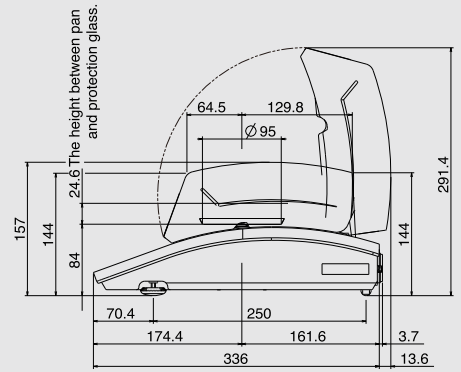
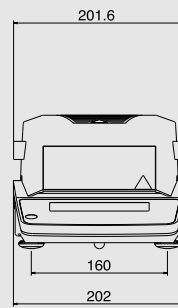
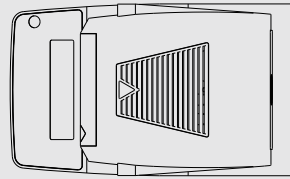

TW/TX/TXB/TWC/TXC Series

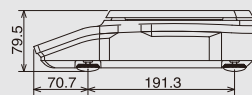
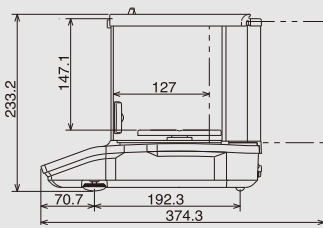
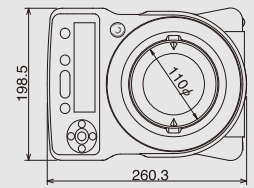
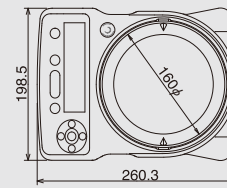
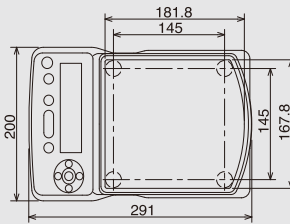
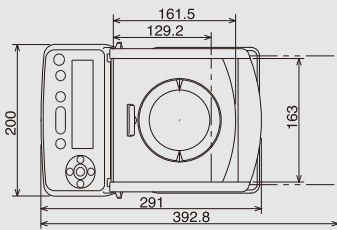

TX/TW series

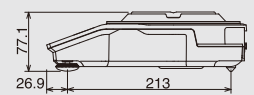
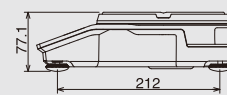

TXB series

Founded in 1875, Shimadzu Corporation, a leader in the development of advanced technologies, has a distinguished history of innovation built on the foundation of contributing to society through science and technology. We maintain a global network of sales, service, technical support and applications centers on six continents, and have established long-term relationships with a host of highly trained distributors located in over 100 countries. For information about Shimadzu, and to contact your local office, please visit our Web site at www.shimadzu.com

For information about Shimadzu Electronic Balances, please visit our Web site at www.shimadzu.com/balance



SHIMADZU CORPORATION. International Marketing Division
3. Kanda-Nishikicho 1-chome, Chiyoda-ku, Tokyo 101-8448, Japan
Phone: 81(3)3219-5641 Fax: 81(3)3219-5710
URL <http://www.shimadzu.com>